

HAMILTON SINKLER

HVT410 Scroll Floor Register 4" x 10"

Available Finishes:
— Bronze Patina

Base Material:
— Solid Bronze

Steel louvers are attached with machine screws to all face plates

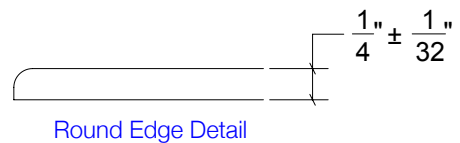
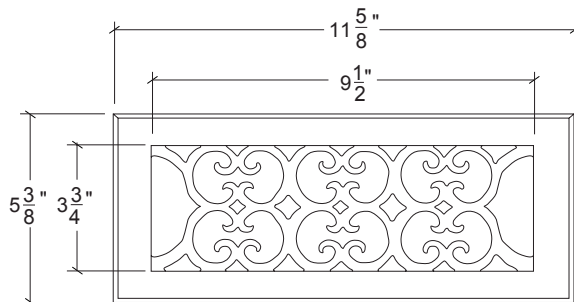

Floor Supply Register: Face plate and pre-attached louvers. Simply drop into place
Wall Supply Register: Face plate with screw holes and pre-attached louvers. Install using wood screws supplied
Return Air Vent: Face plate with screw holes and NO louver. Install using wood screws
Sizing: Measure the size of the duct opening, not the size of the vent cover faceplate
Hamilton Sinkler will pre-attach the louvers with machine screws. No duct tape required

HVAC technical note: the typical open area of the face plate is 60% with non-directional louvers

How to Measure:

To determine the size of register or vent you require, measure the opening in the floor or wall. The most accurate way to determine the size is to measure the duct itself.

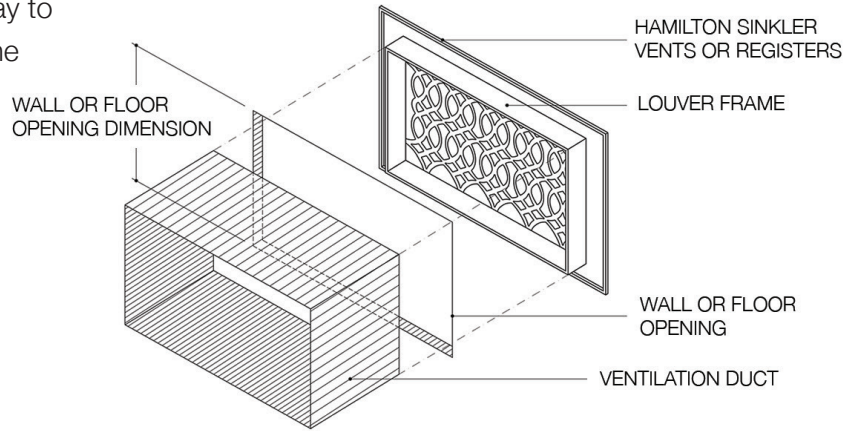

Floor Supply Vents or Registers:

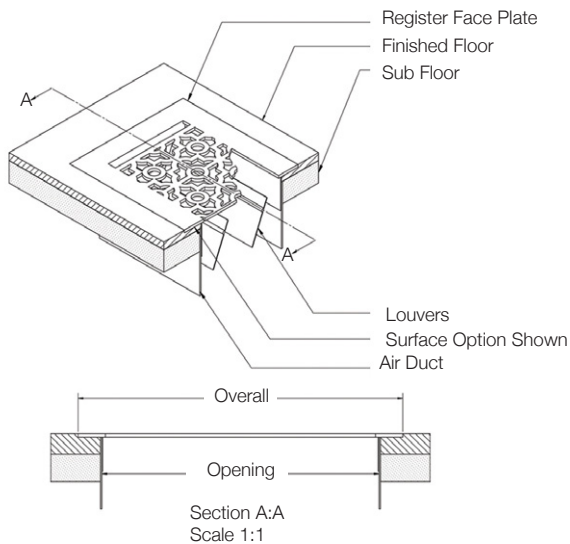

Wall Supply Vents or Registers:

