

HAMILTON SINKLER

HK092 Metropolitan Door Knob

Finishes:

- Antique Brass (AB)
- Bright Antique Brass (BAB)
- Brushed Nickel (BN)
- Burnished Antique Brass (BRAB)
- Burnished Brass (BRB)
- Burnished Nickel (BRN)
- Dull Black (DB)
- Oil Rubbed Bronze (ORB)
- Pewter (PW)
- Polished Black Nickel (BLN)
- Polished Brass with Lacquer (PB)
- Polished Chrome (PC)
- Polished Nickel (PN)
- Satin Brass (SB)
- Unlacquer Brass (UB)

Base Material: Solid Brass

Knob shown with R092 Rosette

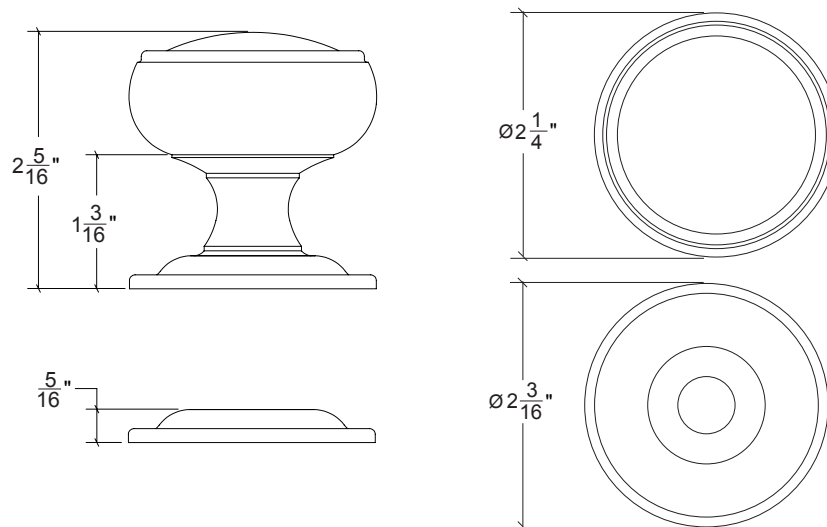

- Custom designs, finishes and sizes available upon request
- Available door functions include entry, passage, privacy, single dummy and full dummy. Other functions available upon request
- Escutcheon back plates in customizable sizes maybe be substituted instead of a rosette
- Interior passage and privacy sets are supplied standard with mini-mortise locks unless otherwise requested
- Entry door sets are supplied with full case mortise locks, are fire-rated, and are available in many function types
- Hamilton Sinkler will select all components to create complete sets as per the configuration of the door

Tel: 212-760-3377
Fax: 212-760-3362

orders@hamiltonsinkler.com
www.hamiltonsinkler.com